



MOBILE FURNITURE

omporro 

ESPRESSIONE AUTENTICA DEL MADE IN ITALY

Autentica espressione del Made in Italy i prodotti per MOBILE rivelano passione, gusto, tecnica e design nell'arredamento. Nascono dall'incontro tra esperienze internazionali ed il DNA di un'azienda con la vocazione per la progettazione e la tecnica.

Il catalogo MOBILE propone una formidabile varietà di **soluzioni**: dallo stile contemporaneo al classico, mantenendo comunque sempre il gusto per l'equilibrio, l'armonia nelle proporzioni, un ideale di bellezza che non si lascia fuorviare da facili mode passeggere.

OMPORRO è il leader nell'innovazione e realizzazione di componenti di arredamento unici:

- l'assortimento di OMPORRO è fra i più completi nel mondo dei complementi d'arredo, per tutte le funzioni d'uso.
- le proprietà dei materiali e delle finiture garantiscono prodotti di qualità superiore per uno stile che mantiene inalterata la sua bellezza nel tempo.



AN AUTHENTIC EXPRESSION OF THE MADE-IN-ITALY STYLE

An authentic expression of the Made-in-Italy style, OMPORRO FURNITURE accessories reveal passion, taste, technique and design skills in furnishings. They are the result of the convergence of international experience and the DNA of a company talented in design and technique.

The FURNITURE catalogue includes a tremendous variety of **solutions** - from contemporary to classic styles, all creations exemplify a taste for balance and harmonious proportions and an ideal of beauty that is not lead astray by any sort of passing trends.

OMPORRO is a leader in innovation and the creation of unique furnishing components:

- OMPORRO offers one of the most comprehensive assortments in furnishing accessories for all purposes worldwide.
- the properties of materials and finishes guarantee products of superior quality and a style whose beauty remains unaltered over time.

- **Decenni di esperienza** nella scelta e lavorazione dei metalli in modo da garantire il perfetto bilanciamento tra durata, resistenza, lavorabilità, destinazione d'uso, stile.

- **Integrazione e controllo di tutto il processo produttivo:** dall'elaborazione tecnica all'imballaggio grazie a 3 unità aziendali in perfetto coordinamento.

- **Ciclo di ideazione e sviluppo interamente all'interno dell'azienda:** progettazione con l'impiego di sofisticati programmi di ingegnerizzazione; realizzazione di stampi e di macchine utensili mediante l'officina attrezzata.

- **Eccellenza tecnica e meccanica** nel processo produttivo grazie alle oltre **430 macchine utensili** di alta precisione.

- **Maestria nelle tecniche decorative:** finitura, verniciatura, trattamento PVD (Physical Vapour Deposition).

- 10 test che garantiscono la **più alta qualità del Made in Italy.**

- **Tecniche di imballaggio specifiche** per oggetti preziosi.



TECHNICAL, AESTHETIC AND DECORATIVE EXCELLENCE



ECCELLENZA TECNICA, ESTETICA E ORNAMENTALE



- **Decade-long experience** in choosing and working with metals in order to guarantee the perfect balance between durability, resistance, workability, function and style.

- **Integration and control of the entire production process:** from design to packaging, thanks to 3 perfectly coordinated company units.

- **Research and development cycle performed entirely within the company:** the design process makes use of sophisticated engineering programs, moulds and machine tools created in the tooling workshop.

- **Technical and mechanical excellence** in the production process thanks to over **430 machine tools.**

- **Mastery of decorative techniques:** finishing, coating, PVD treatments (Physical Vapour Deposition).

- 10 tests that guarantee the **highest Made-in-Italy quality.**

- **Specific packaging techniques** for valuable objects.

DESIGN E STILE

La gamma di finiture per ottone OMPORRO è quanto di più vasto esista sul mercato.

Diciotto finiture, frutto di decenni di esperienza, che garantiscono la massima resistenza nel tempo, per poter scegliere la tonalità più idonea in ogni ambiente.

Per ogni prodotto è stata scelta la gamma cromatica che più si adatta al design proposto. Data la varietà di queste combinazioni si rimanda al listino per l'insieme delle finiture relative ad ogni oggetto.

Oltre alle tonalità per l'ottone il catalogo OMPORRO presenta articoli in acciaio inossidabile e alluminio con finitura lucida e satinata.

- | | |
|--------------------------------|-------------------|
| 1 oro | 10 nickel nero |
| 2 oro satinato | 11 patinato steel |
| 3 bronzo antico | 12 cromo satinato |
| 4 ottone antico | 13 bagno oro |
| 5 oro antico | 14 oro PVD |
| 6 ramato antico non verniciato | 15 bagno oro PVD |
| 7 nickel lucido | 16 nero PVD |
| 8 nickel satinato | 17 oro antico PVD |
| 9 cromo | 18 inox PVD |

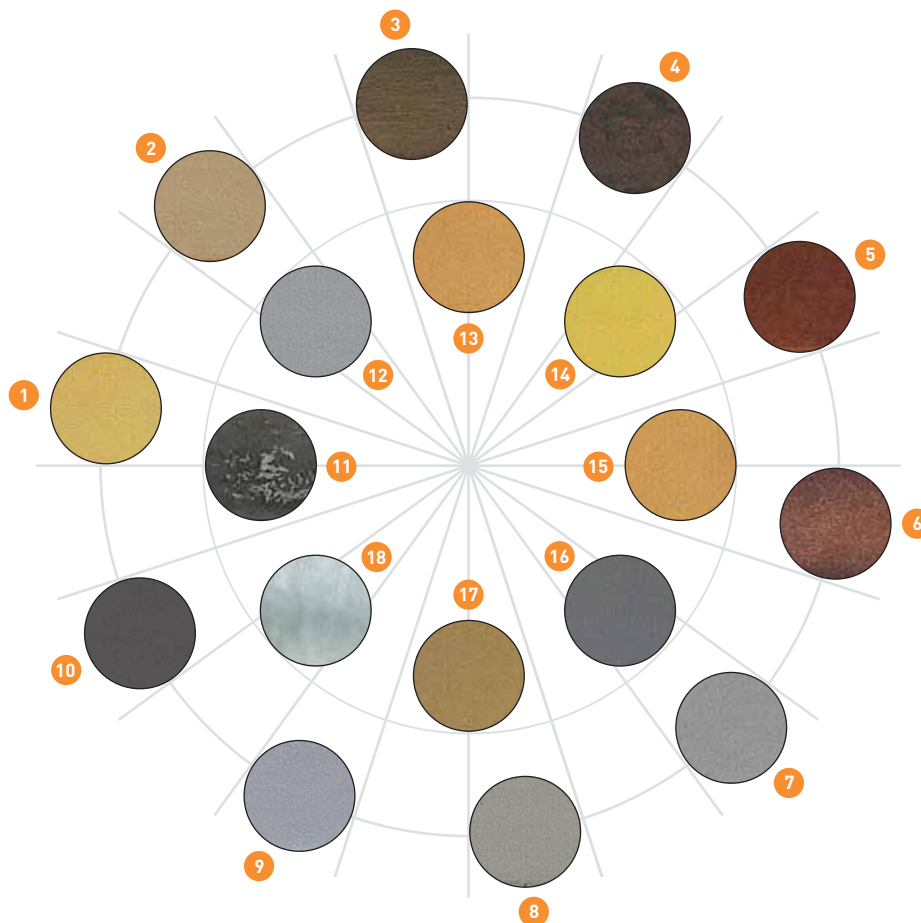

I colori delle finiture sono indicativi.

The finish colours may differ.

DESIGN AND STYLE

OMPORRO's range of brass finishes offers a variety currently unmatched in the market.

The result of decades of experience, these eighteen finishes guarantee maximum durability over time and enable customers to select the most suitable shades for any environment.

The colour range for each product has been carefully chosen so as to best complement its design. Given the variety of these combinations, customers should consult the catalogue to get acquainted with all available finishes for each item.

In addition to various shades of brass, the OMPORRO catalogue also features items in stainless steel and aluminium in polished or satin finish.

- | | |
|-------------------------------|---------------------|
| 1 bright brass | 10 black nickel |
| 2 satin brass | 11 pewter |
| 3 bronze | 12 satin chrome |
| 4 ancient brass | 13 gold plated |
| 5 old gold | 14 bright brass PVD |
| 6 antique copper not laquered | 15 gold plated PVD |
| 7 bright nickel | 16 black nickel PVD |
| 8 satin nickel | 17 old gold PVD |
| 9 chrome plated | 18 inox PVD |



POMOLI KNOBS





156
mm 30|36



157
mm 40





199
mm 15|20|25|30|40|50



158
mm 20|25|30|35|40



100
mm 20|25|31|40



101
mm 13|20|25|30|35

142

mm 20|25|30|35



164

mm 20|25|30|35|40

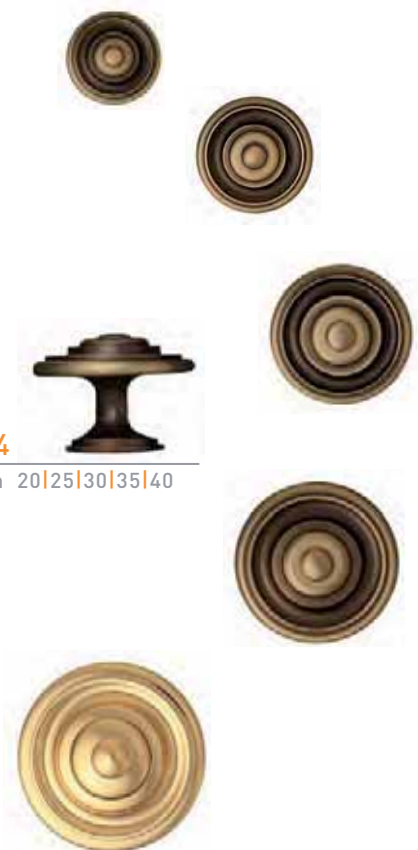

161

mm 17|21|26|32|40

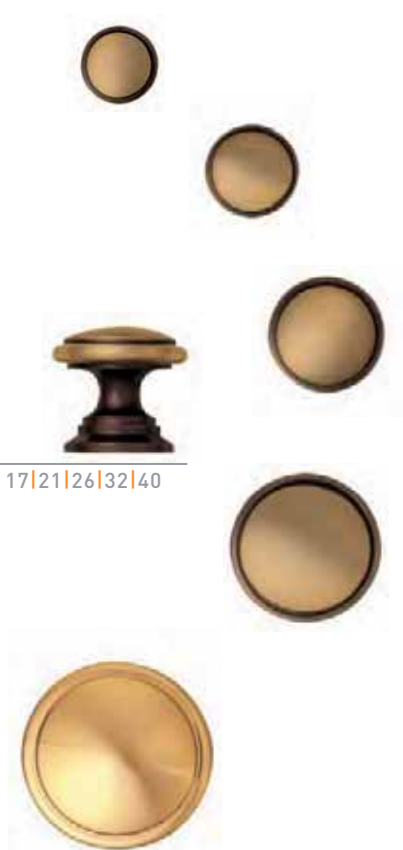

141

mm 30|35|40



102

mm 20|25|30|40



160

mm 13|17|21|26|32|40



136

mm 25|30|35|40



137

mm 25|30|35

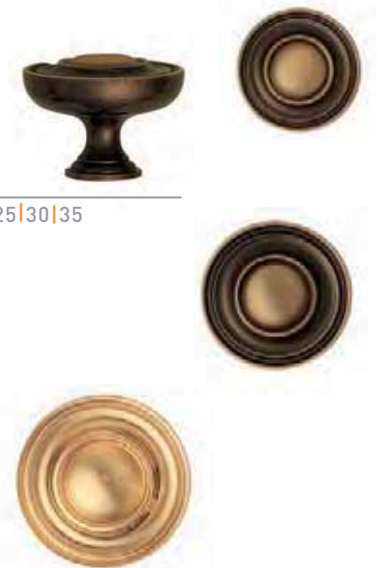

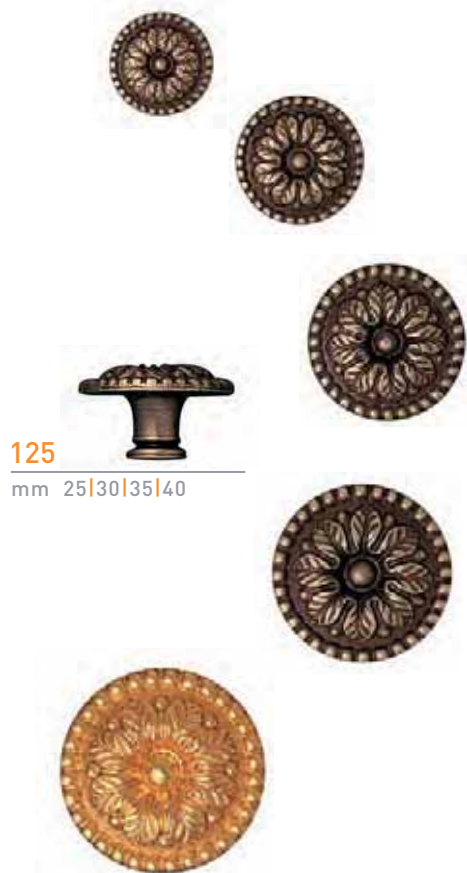

125

mm 25|30|35|40

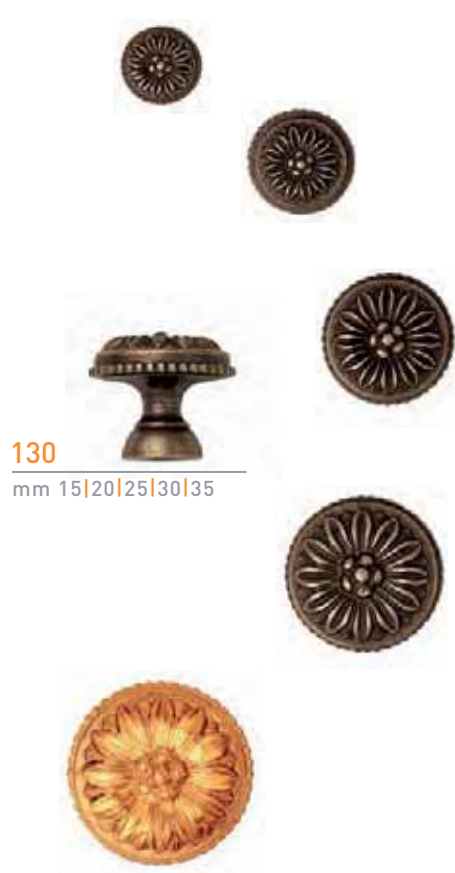

130

mm 15|20|25|30|35

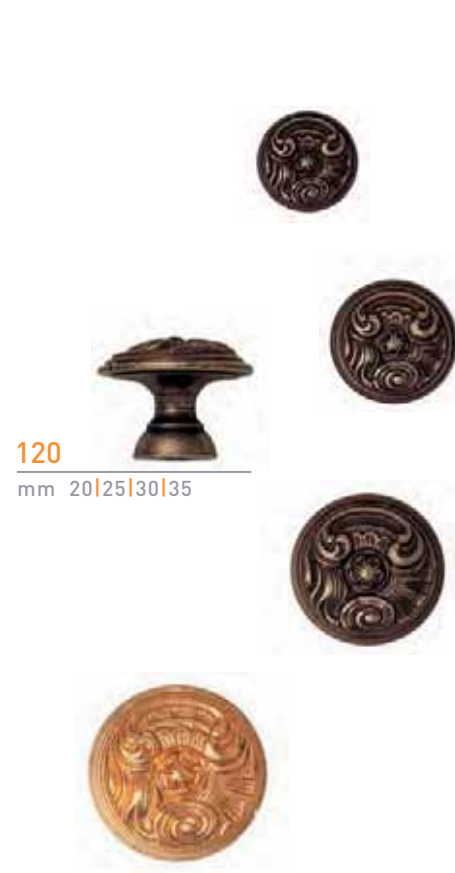

120

mm 20|25|30|35

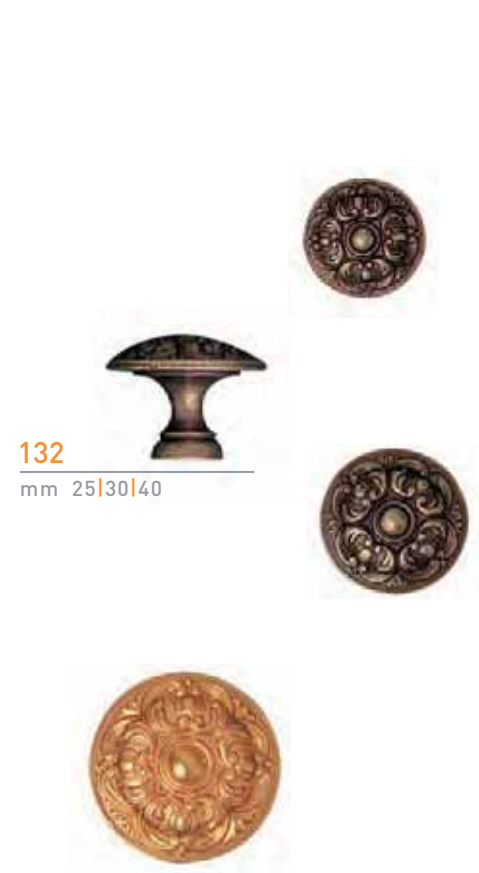

132

mm 25|30|40



150

mm 20|28|33|40



140

mm 25|30|35

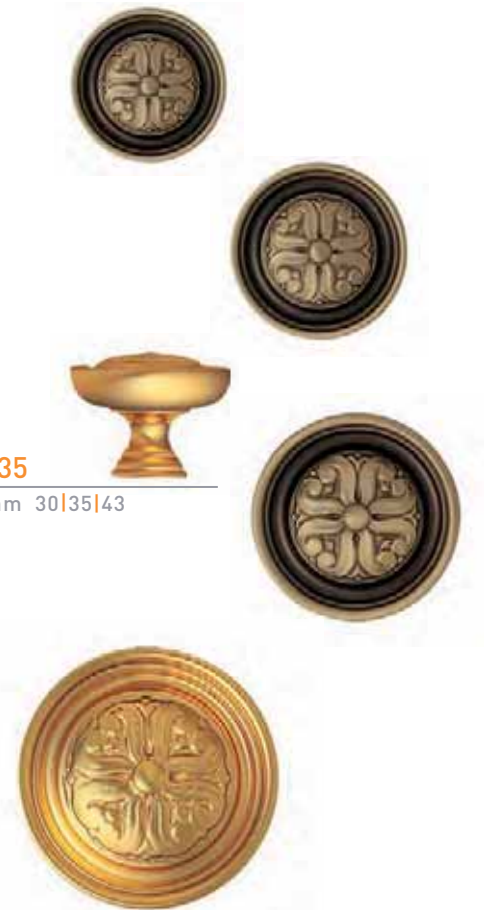

135

mm 30|35|43



175

mm 28|35|38



A = verde | green



B = rosa | pink



C = azzurra | light blue



D = millefiori | patchwork



E = nero | black



178

mm 27|32|35

153

mm 12|15|18|21|25



107

mm 20|25|30|35

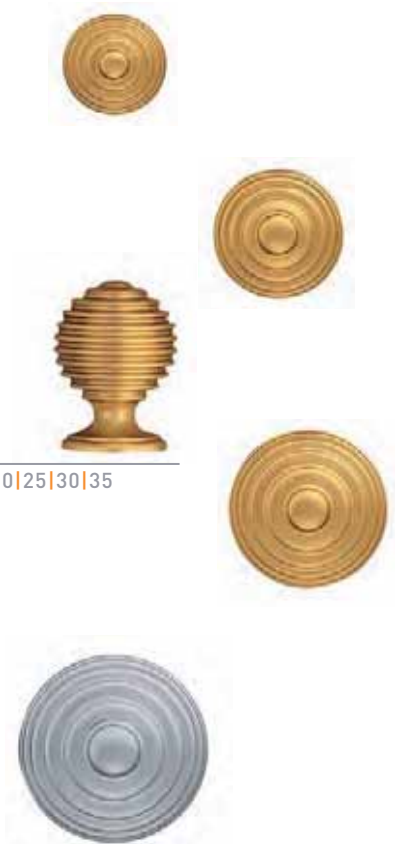

147

mm 20|25|30



182

mm 25|30





184

mm 25|30



170

mm 25|30|35|55



151

mm 20|25|30



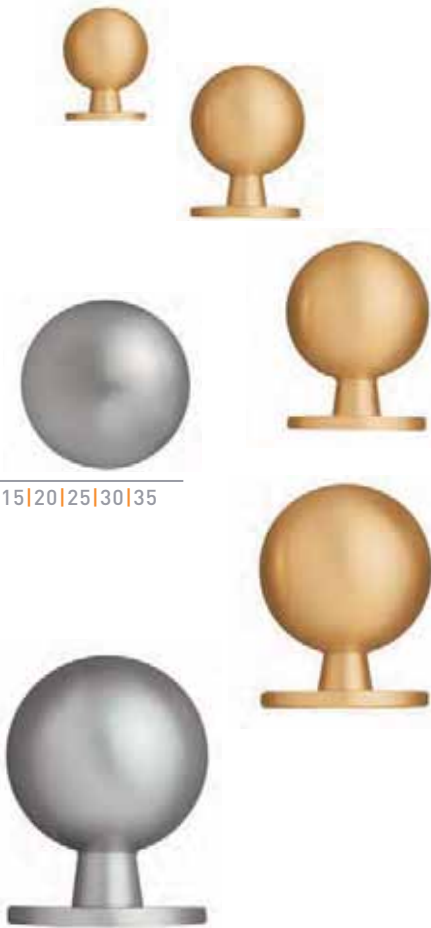

165

mm 15|20|25|30|35



168

mm 25|30|35



146

mm 25|30|40|55





145

mm 25|30|40



163

mm 25|30|35|40



105

mm 25|30|35





POMOLI ACCIAIO STAINLESS STEEL KNOBS



AI 0100

mm 20|25|30

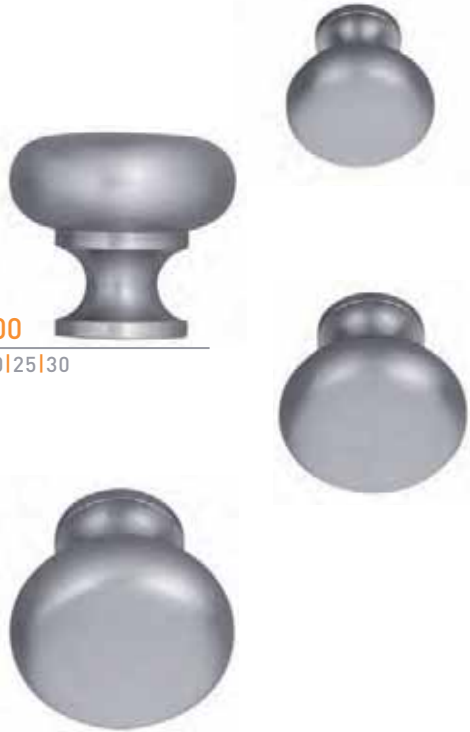

AI 0160

mm 20|25|30



AI 0180

mm 15|20|25|30





AI 0181

mm 20|24|30



AI 0153

mm 15|18|21





POMOLI ALLUMINIO ALUMINIUM KNOBS

POMOLI ALLUMINIO ALUMINIUM KNOBS



AL 0190

mm 15|18|21



AL 0192

mm 15x15|20x20





MANIGLIE HANDLES





400
mm 32|64|96



405
mm 64|96



405 P



404
mm 64|96



403
mm 32|64|96



419
mm 32|64|96



451

mm 64|96



464

mm 96|128|160|192|224|256|288|320|352|384|416|448|480|512|544|704|768



406

mm 96|160



406 S



461

mm 96|160



461 P



522

mm 64|96|192



523



527
mm 64|96

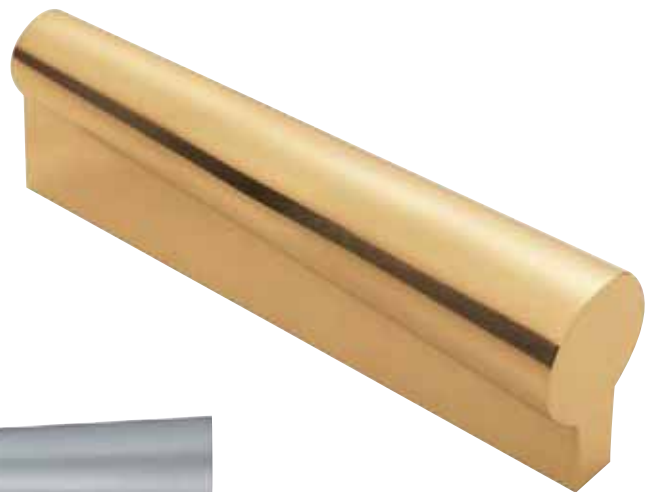

528
mm 32



714
mm 128



PF 0400 *pininfarina*
mm 96|160



PF 0400 P *pininfarina*



454
mm 64



524

mm 32|64|96



525

mm 16|64|96

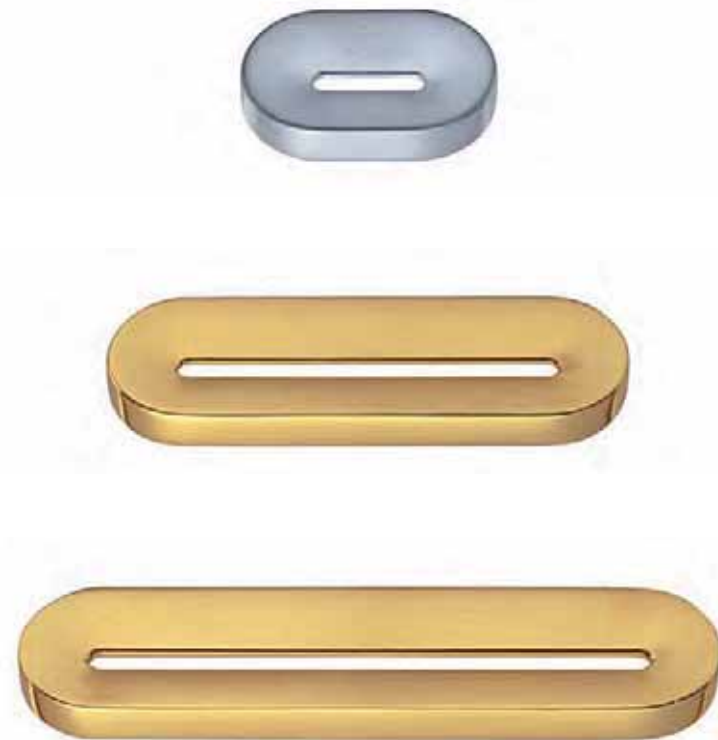

526

mm 32|64





maniglia magnetica con incasso da entrambi i lati

594 A
mm ø 60

magnetic handle recessed on each side



maniglia magnetica con incasso e interno piano

594 B
mm ø 60

recessed magnetic handle with plane interior surface



maniglia magnetica con incasso e pomolo

594 C
mm ø 60

recessed magnetic handle with knob





586
mm 33|39



587
mm 40x30
mm 50x38
mm 60x47



587 BA
mm 40x30
mm 50x38
mm 60x47



580
mm 50



596

mm 30|40|50|60

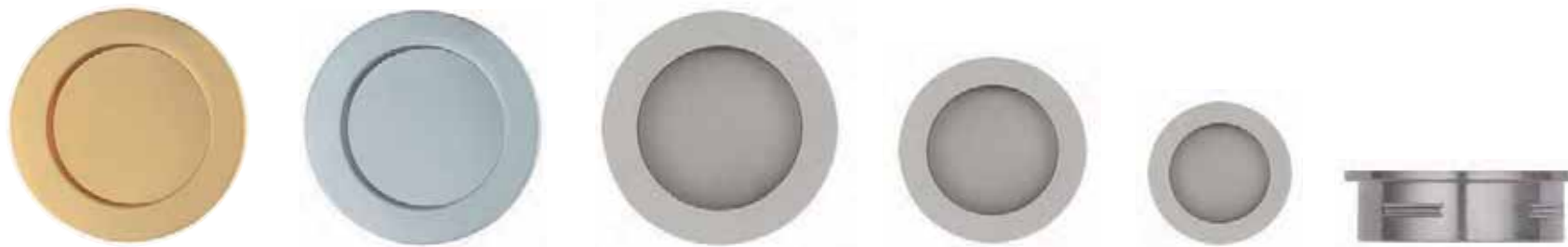

595

mm 30|40|50|60|80|120

598

mm 64|96|128|160



598 OV

mm 64|96|128|160

499

mm 34|40|50



431

mm 78



441

mm 96



440

mm 64|72|100|115



472

mm 64|96



465

mm 80|100

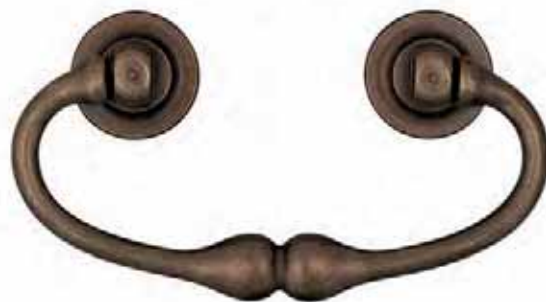

466

mm 60



467

mm 50

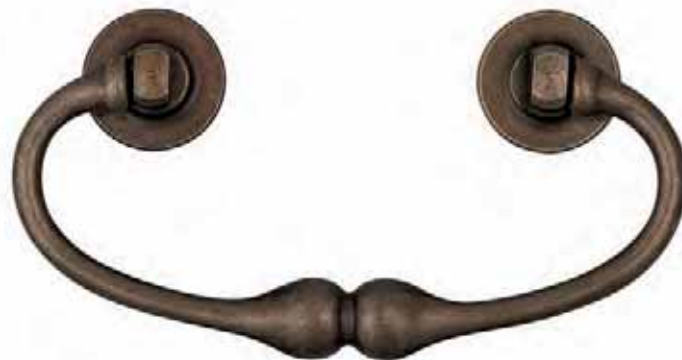

443

mm 64|72|100|115

413

mm 65|80|90

420

mm 75|95



422
mm 64



421
mm 35





463
mm 35|45



470
mm 90|120



456
mm 100|140



435
mm 100|125|160|210



645
mm 32|42|57



438

mm 38|42



323

mm 50|70



650

mm 32|39|46



671

mm 35



670

mm 35|45|60





390
mm 42|55



424
mm 50|70



425
mm 95|120



423

mm 90|130|190





MANIGLIE ACCIAIO STAINLESS STEEL HANDLES



MANIGLIE ACCIAIO STAINLESS STEEL HANDLES

AI 0450

mm ø 10x96|128|160|192|320



AI 0450 R

mm ø 10x96|128|160|192|320



AI 0464 S

mm ø 10|12|14x96|128|160|192|224|256|288|320|352|384|416|448|480|512|576|640|704|736



AI 0466

mm ø 10x96|128|160|192|224|320|480|640|736



AI 0465

mm ø 12x96|128|160|256|320|480|640|736

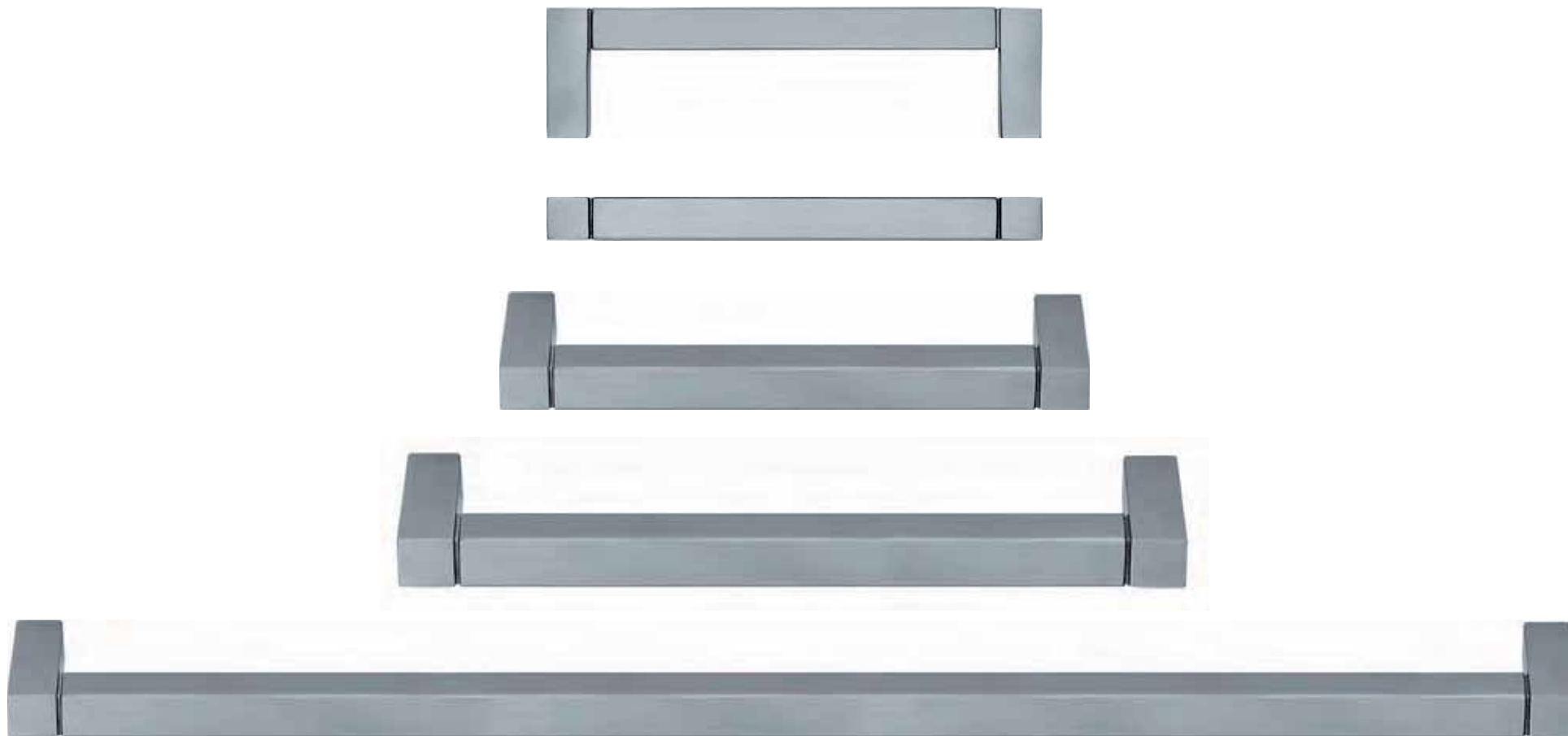

AI 0468

mm ø 15x160|224|288|320|480|640|736|800



AI 0469

mm ø 12x160|224|288|320|480|640|736|800



AI 0537

mm \emptyset 8x64|96|128|160|192|256|320|384

mm \emptyset 10x64|96|128|160|192|224|320|384|480



AI 0470

mm 64|96|128|160|192|320





MANIGLIE ALLUMINIO ALUMINIUM HANDLES



AL 0410

mm 160|192|320|448|640|736



AL 0406

mm 160|320|448|640|736

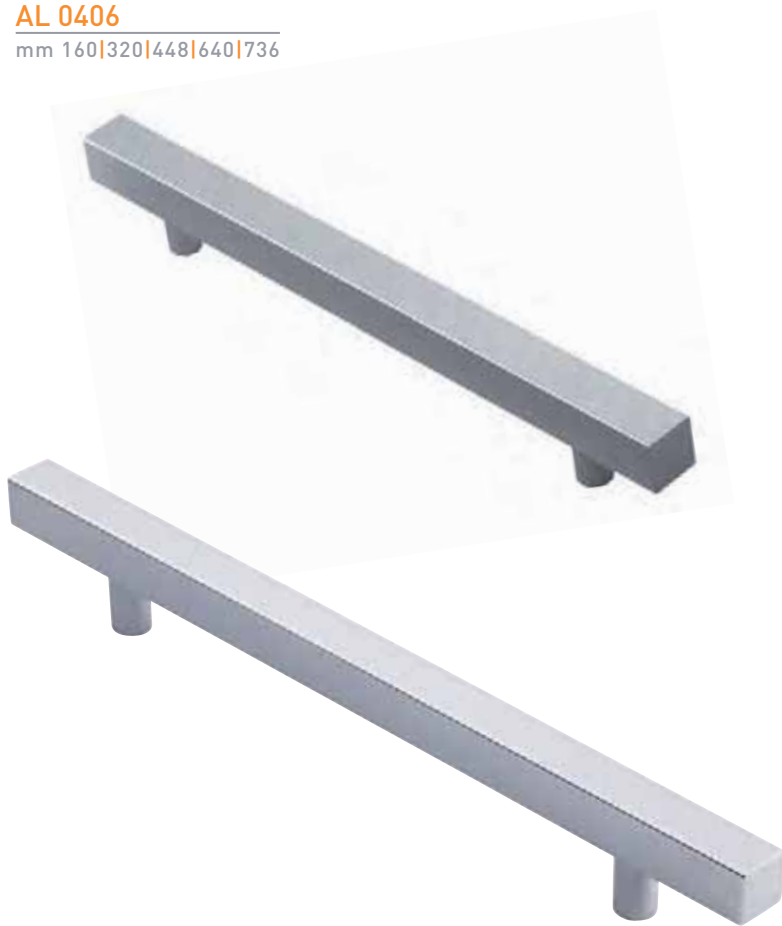

AL 0409

mm 128|160|192|224|256|320|352|448|512|640|800



AL 0401

mm 160|320|448|640|736



AL 0408

mm 160|320|448|640|736



AL 0404

mm 160|320|448|640|736



AL 0400

mm 160|320|448|640|736



AL 0599

mm 128|160|200|500|700



AL 0407

mm 96|128|160|320|448|640|736





MANIGLIE PER ANTE VETRO GLASS-DOORS HANDLES

538 V

mm ø 14x160

192

256



AI 0464 V

mm ø 16x160

192

256



AI 0534 V

mm ø 14|128|160|192|224|256|320|448|480



AL 0410 V

mm 160

192

320

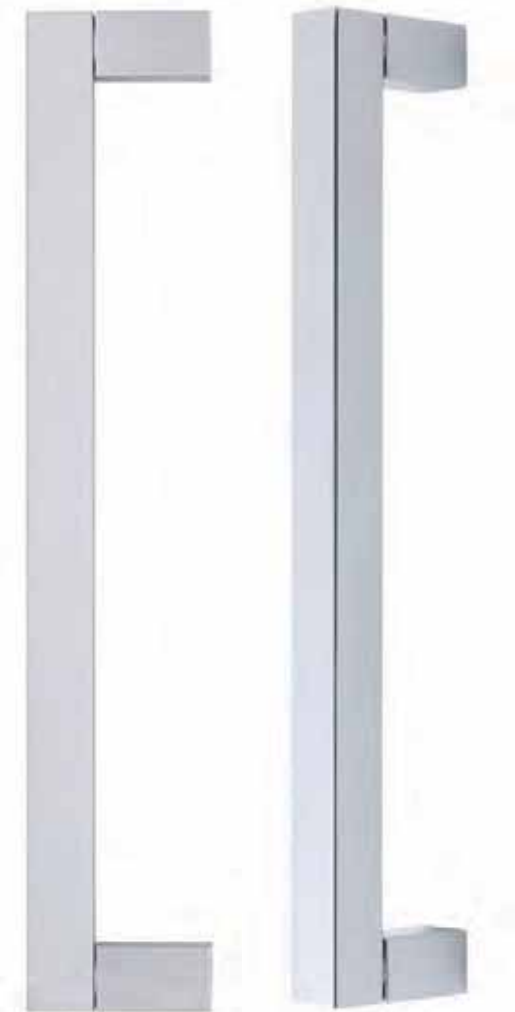

incasso/incasso

597 A
mm ø 60

flush handle/flush handle



incasso/piano

597 B
mm ø 60

flush handle/smooth part



incasso/pomolo

597 C
mm ø 60

flush handle/knob part

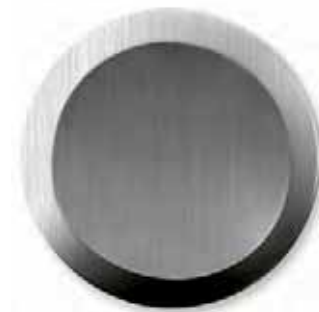



184 V

mm ø 30



153 V

mm ø 25



AL 0408 V

mm 260|410|560

con sistema biadesivo 3M
with 3M double-sides tape system



AL 0404 V

mm 230|380|530

con sistema biadesivo 3M
with 3M double-sides tape system



AL 0401 V

mm 240|390|540

con sistema biadesivo 3M
with 3M double-sides tape system



AL 0400 V

mm 240|390|540

con sistema biadesivo 3M
with 3M double-sides tape system



CHIAVI KEYS



9
mm 40|50



75
mm 40



28
mm 30|40



56
mm 35|45



74
mm 30|40



55
mm 35|45



48
mm 32|42



48 T



15
mm 30|40|45



30
mm 33|42



30 T



17
mm 30|38



26
mm 30|35|40|45



26 T



16
mm 30|35|40



33
mm 30|35|40|45



33 T



44
mm 33|45



23
mm 42



23 C



45
mm 35|42



53
mm 32|42



53 C



41
mm 35|45



17 P



33 GP



16 P



16 M
mm 30



75 P



68 P



34 M
mm 37



17 M
mm 35



26 M
mm 30



27 M
mm 34



BOCCHETTE ESCUTCHEONS



336
mm 25|30|35



300
mm 29|37|47



671
mm 35

332
mm 35

421
mm 35



323
mm 50|70



306
mm 32|40

310 dx - sx verticale/vertical
mm 90|130|170|220



310 orizzontale/horizontal
mm 90|120



ACCESSORI PER MOBILE FURNITURE ACCESSORIES



PF 1001 *pininfarina*
mm 100|150



1025 P extension
mm 40



1025
mm 100|150



1025 P extension
mm 40



1026
mm 100|150



1025 P extension
mm 40



1027
mm 100|150



1025 P extension

mm 40



1025 P extension

mm 40



1028

mm 100|150



1029

mm 100|150



1030

mm 120|140



1040

mm 120|150|190



AP04

mm 70x70



AP01

mm 95x126



AP02

mm 60x60



1015

mm 21|23|25|27|30|35



1010

mm 23|25|27|30|35



200

mm 19|24|28|33|42



206

mm 24|33



208

mm 30|40



207

mm 33|50



852

mm ø 9|11|13|16|20|25|30|35|40x1500|2000|2500|3000|5000

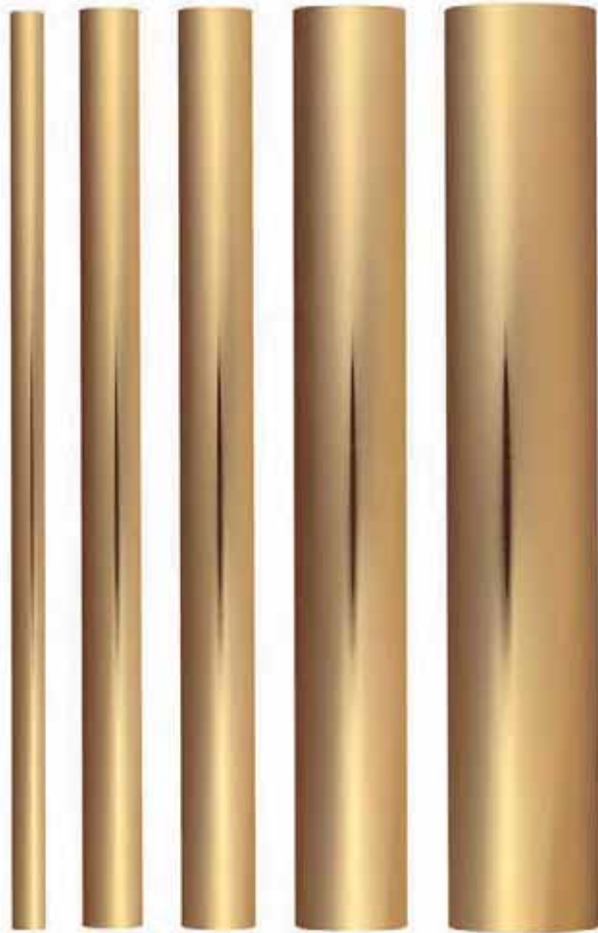

852 R

mm ø 25|30|35x2000|3000|5000

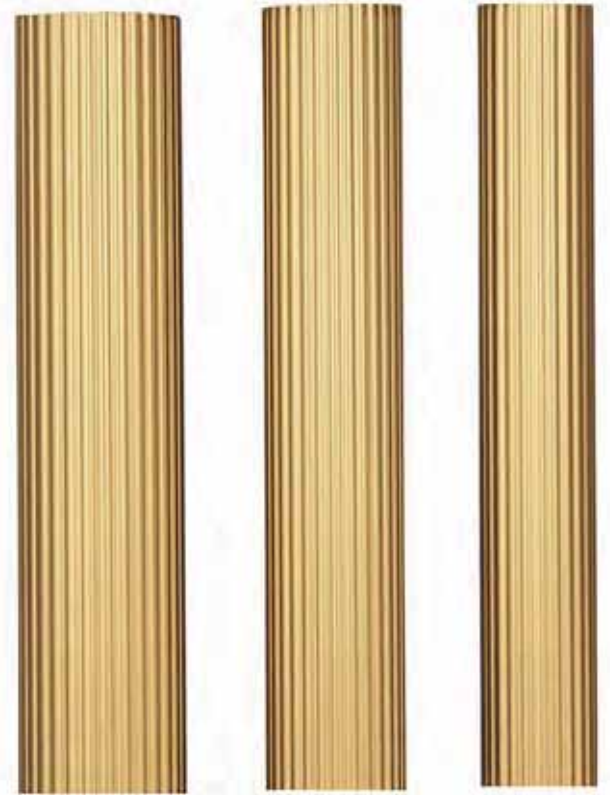

852 C x 90°

mm ø 11|13|20|25|30|35|40



803

mm ø 13|18|20|25



803 E

mm ø 18



840

mm ø 11|13|16



841 dx/sx

mm ø 20|25



865

mm ø 10|12|14|16|20|25



874 dx/sx
mm ø 16|20|25|30



874 A
mm ø 16|20|25|30



760 CG

mm ø 15|20|25|30|35|40|50



760 FS

mm ø 15|20|25|30|35|40|50



761

mm ø 15|20|25|30|35|40|50



473 dx/sx

mm 45x55



473 bis dx/sx

mm 45x55



473 BT dx/sx

mm 45x55



474

mm 63x35

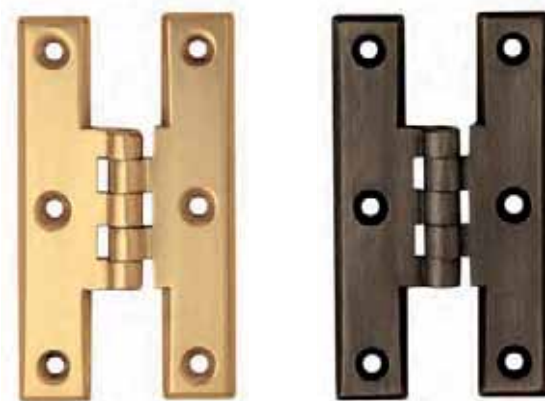



SISTEMA RELING RELING SYSTEM



874 dx/sx

mm ø 16|20|25|30



874 A

mm ø 16|20|25|30



2000

mm ø 16



2001

mm ø 11|13|16x40|70

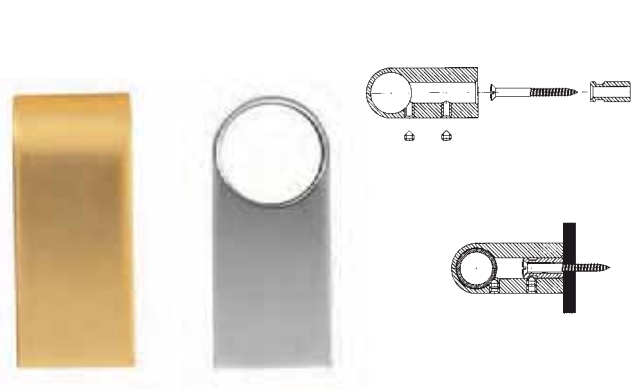

2000 M

mm ø 6|8|10

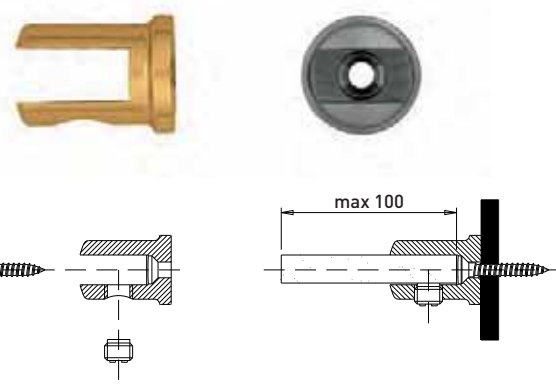

2001 M

mm ø 6|8|10

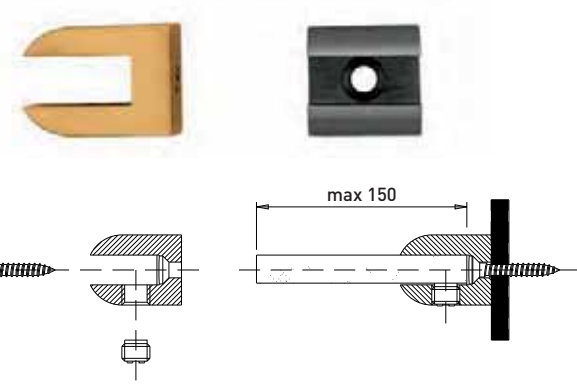

3075

mm ø 16x1000|1500|2000|2500|3000



3075 C 90°

mm ø 16



3075 C 135°

mm ø 16

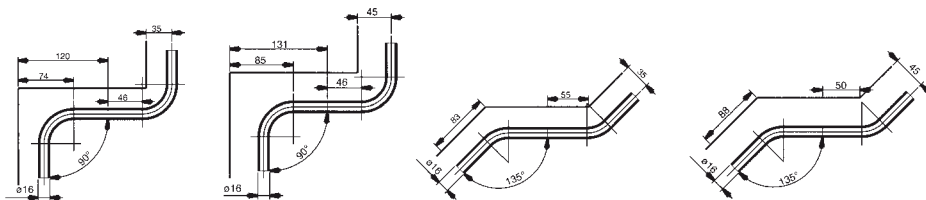

2010

mm ø 16



2011

mm ø 16



CV001



803

mm ø 13|18|20|25

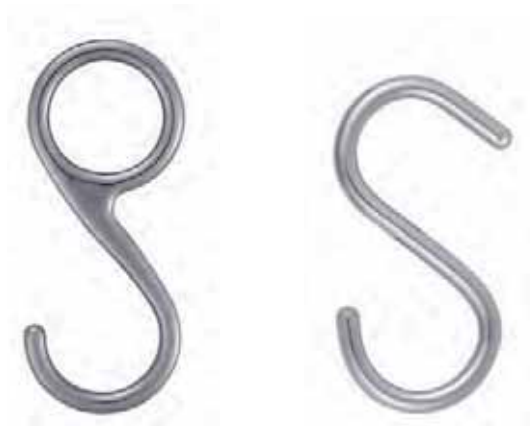

803 E

mm ø 18

2060

mm 150|200|250



2050

mm 2000



2061

mm 200|250



2051

mm 2000



2015
mm 200

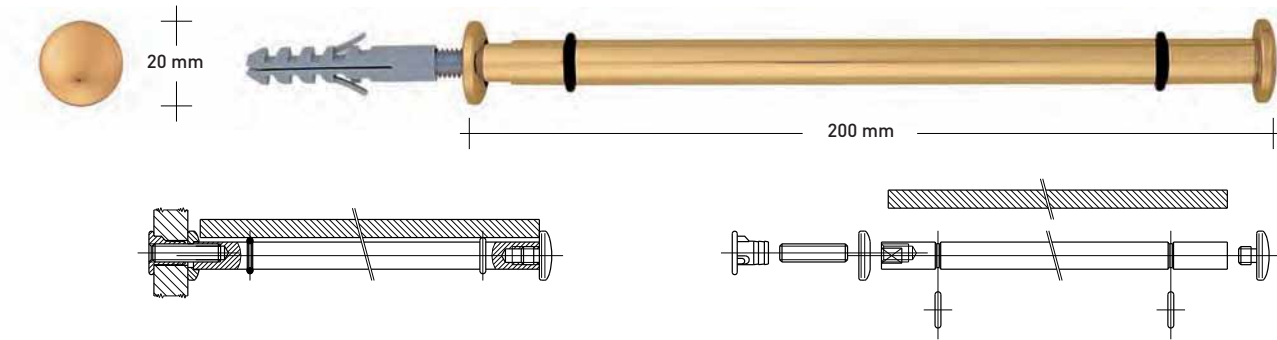
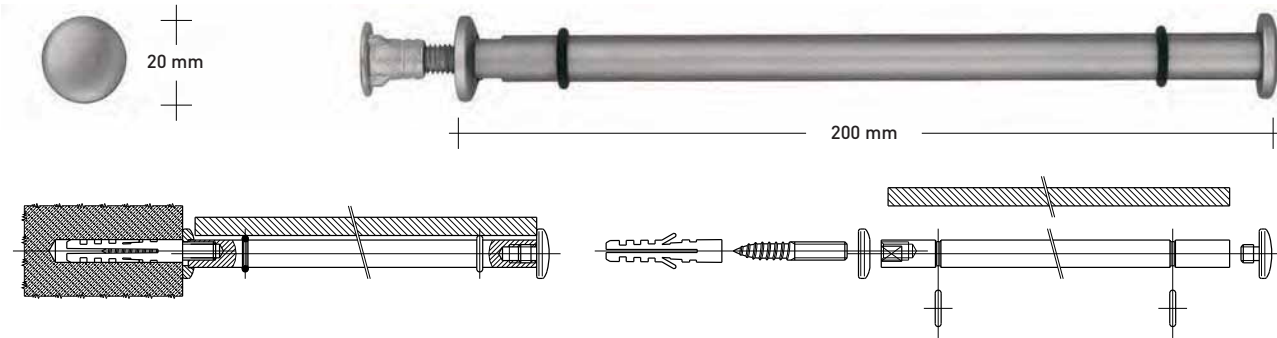

SE 2015 set

n° 2 cod 2015
n° 1 vetro temperato/tempered glass
mm 600x200

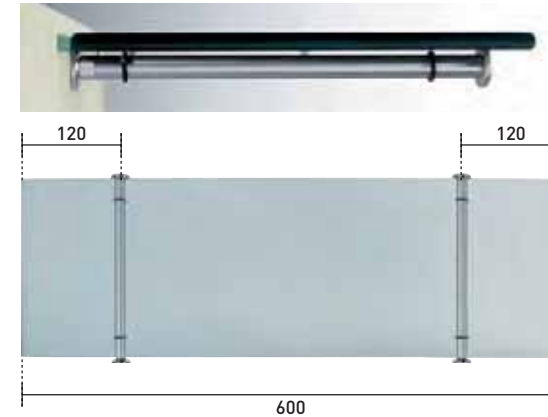

2017
mm 200

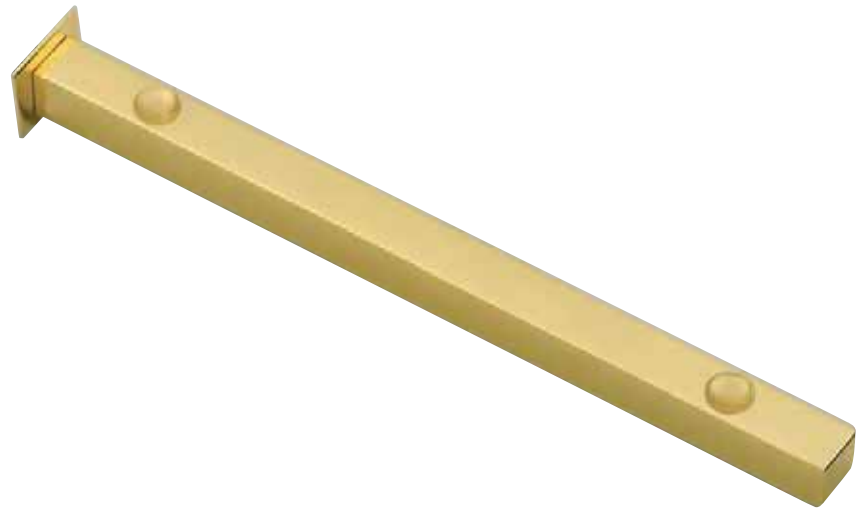

SE 2017 set

n° 2 cod 2017
n° 1 vetro temperato/tempered glass
mm 600x200

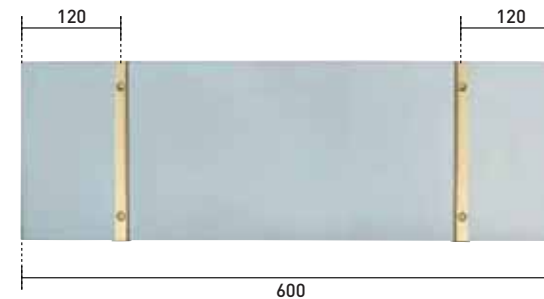

Portata max singolo elemento kg 50
Capacity max single element kg 50

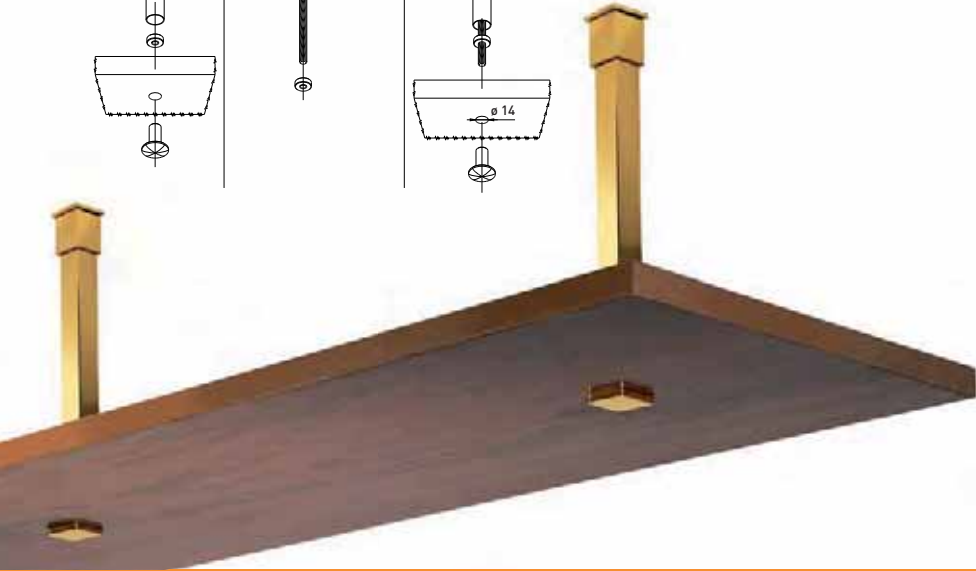
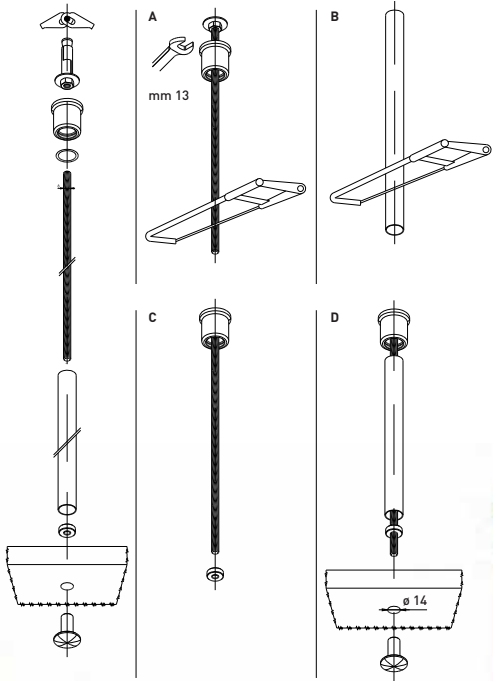

sistema reling

2025
mm 1000|1200



reling system

AI 2025
mm 1000|1200



2026
mm 1000



AI 2026
mm 1000|1200





ACCESSORI ACCESSORIES

ACCESSORI ACCESSORIES

AI 2030

mm \varnothing 16x300|450|600





2070

mm 26x275



PF 2000 *pininfarina*
mm 170



842

mm ø 11|13|16|20|25|30

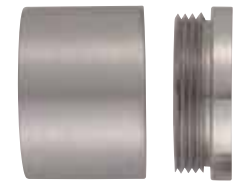

852 GI

mm ø 25|30|35|40



852

mm ø 9|11|13|16|20|25|30|35|40x1500|2000|2500|3000|5000





PORTABITI COAT-HANGERS

AI 1542

mm ø 14x35



1517

mm 35



1522

mm 30



1516

mm 82



1504

mm 40x200



1503

mm 30x125



1505

mm 20|28|35|42|50



1510

mm 30|50



1511

mm 196



1509

mm 25|35|45



1506

mm 20|28|35|42|50



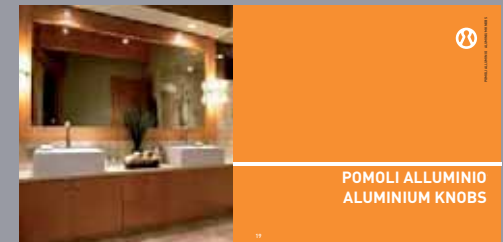
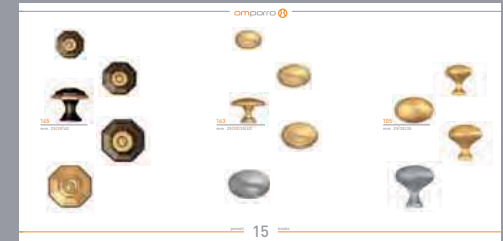
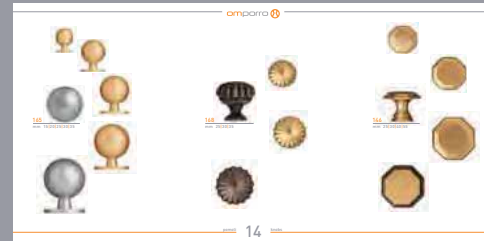
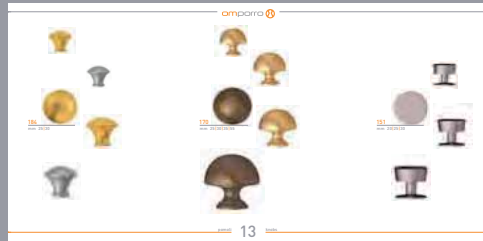
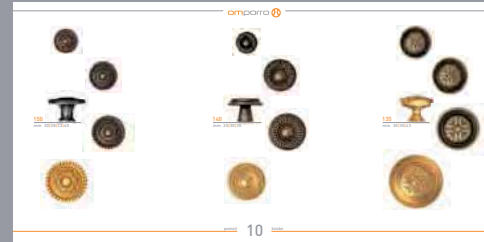
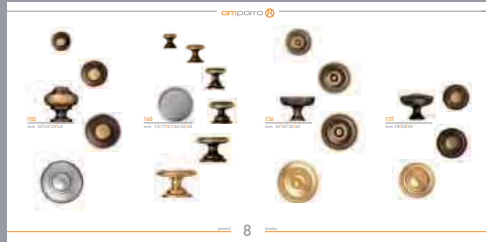
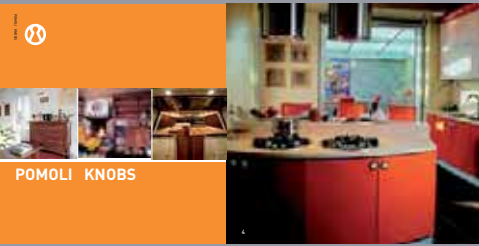

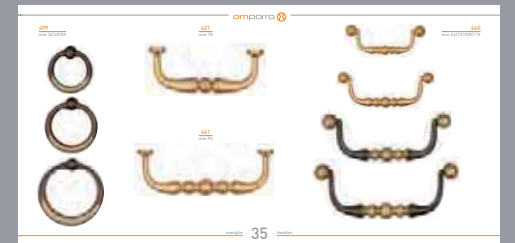
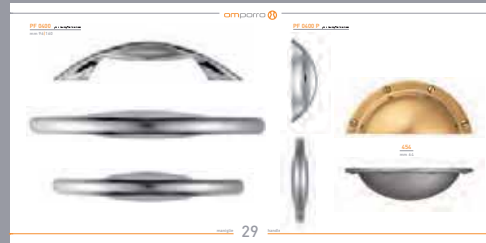
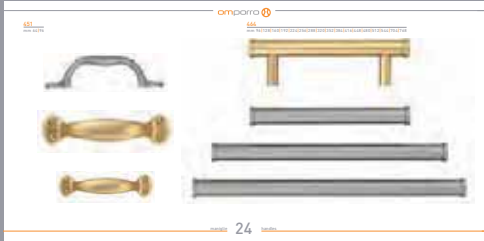
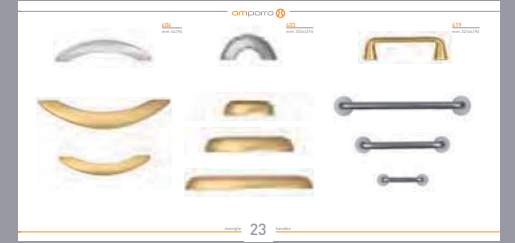
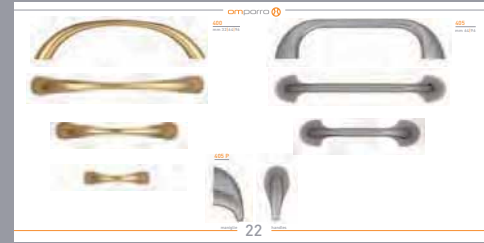

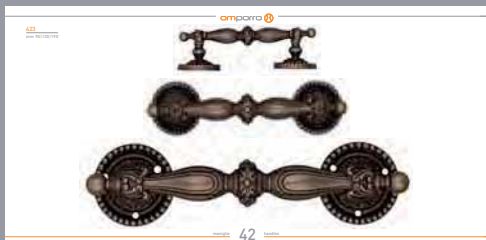
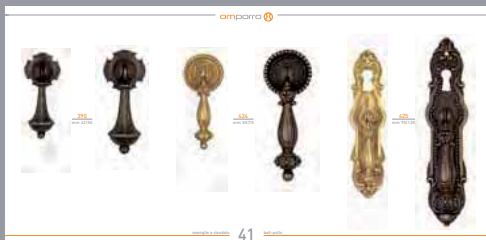
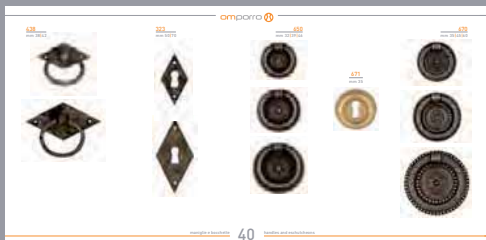
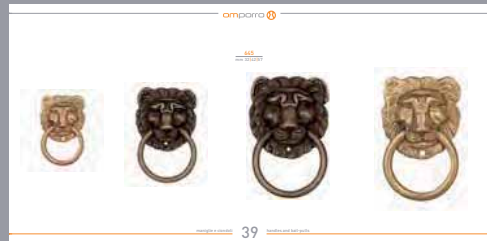
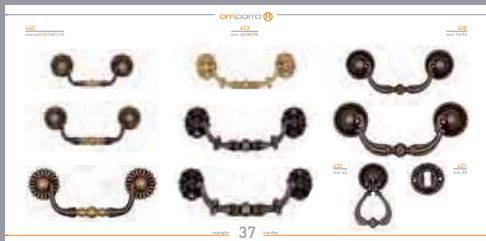
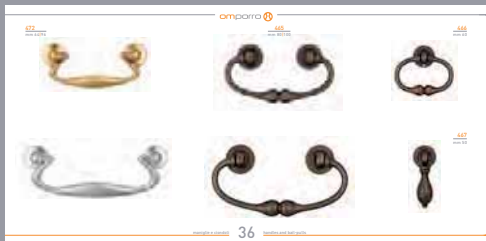

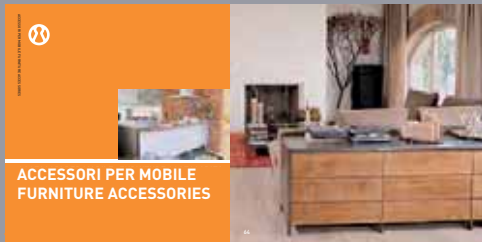
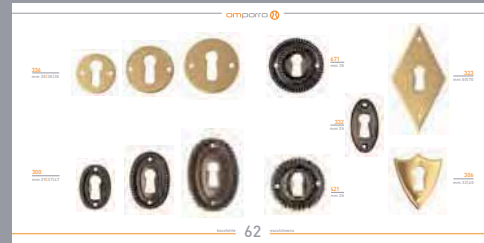
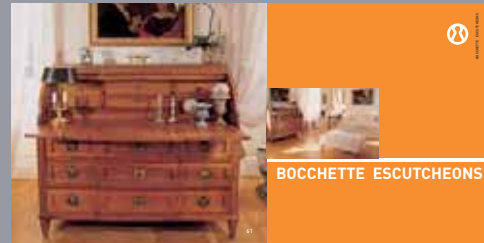
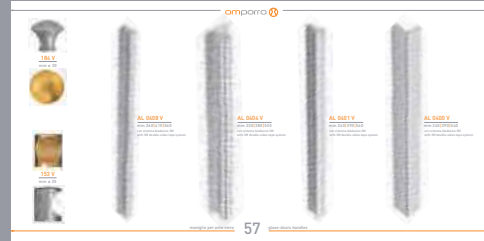
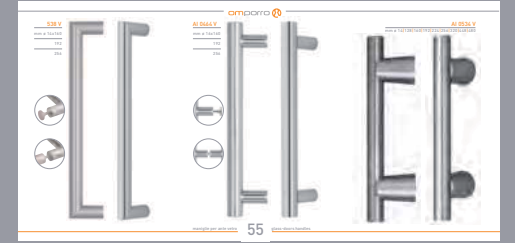

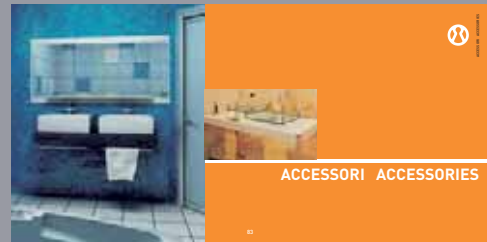
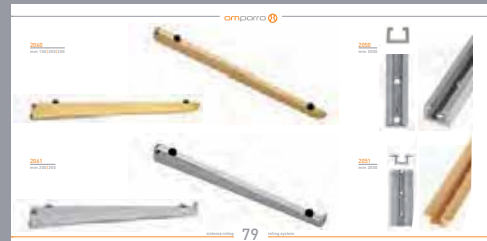
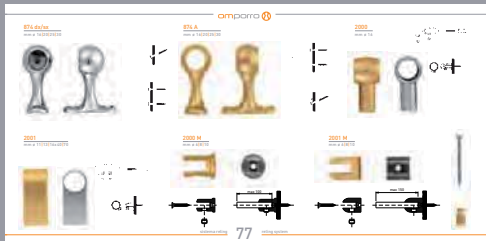
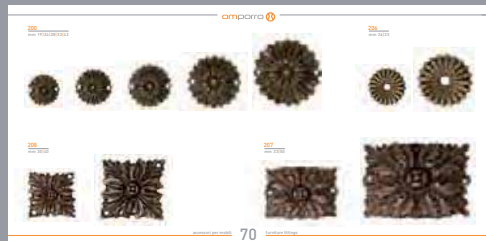
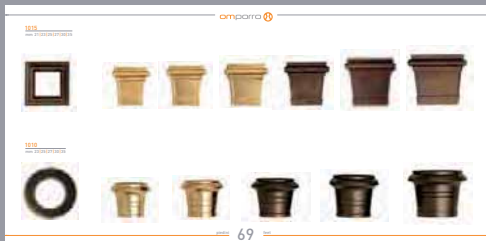

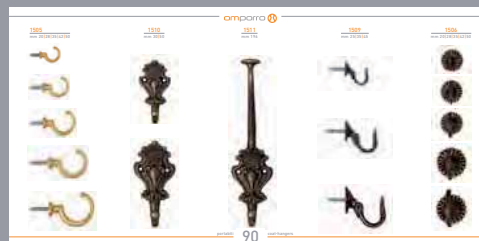
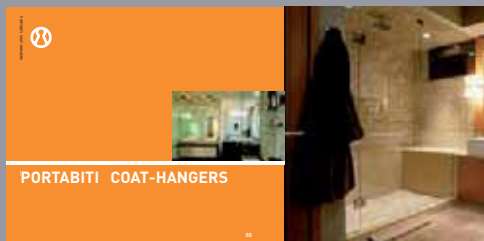
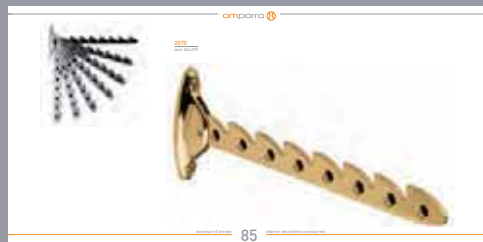
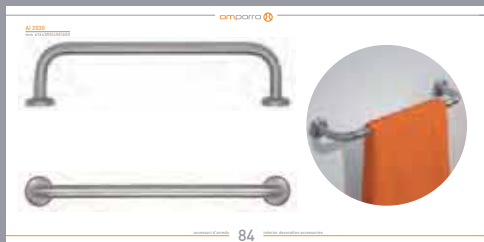

Ove non altrimenti specificato (Al=Acciaio / AL=Alluminio) i prodotti sono in ottone.
I prodotti sono disponibili in un numero di finiture maggiore rispetto a quello mostrato nella pagina di descrizione dell'oggetto. Si rimanda quindi al listino per l'insieme completo delle finiture relative a ogni prodotto.
OMPORRO si riserva il diritto di modificare senza preavviso le caratteristiche tecniche, estetiche e funzionali dei prodotti presenti in questo catalogo.

All products are brass, if not otherwise specified (Al=Stainless steel / AL=Aluminium).
Products are available in more finishing than the ones specified on the page, where the product is described. Please refer to the Price List for a complete view of the finishing related to each single product.
OMPORRO reserves the right to modify without notice the technical, aesthetical and practical features of the products contained in this catalogue.

